

AVerMedia® AVerVision CP300

User Manual

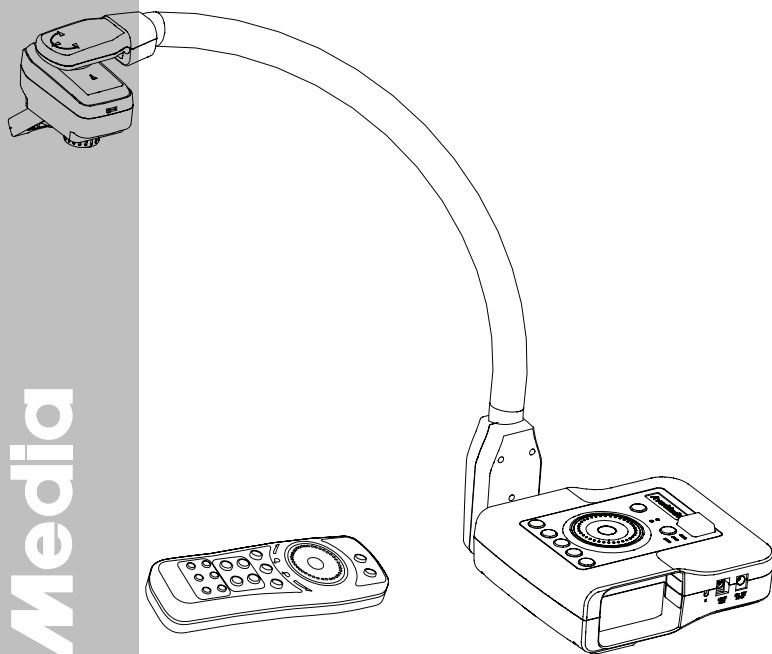

AVerMedia

AVerMedia®
Digital Document Camera



P/N 300AP0A7-CPF
Made in Taiwan

FCC NOTICE (Class A)



This device complies with Part 15 of the FCC Rules. Operation is subject to the following two conditions: (1) this device may not cause harmful interference, and (2) this device must accept any interference received, including interference that may cause undesired operation.

Federal Communications Commission Statement

NOTE- This equipment has been tested and found to comply with the limits for a Class A digital device, pursuant to Part 15 of the FCC Rules. These limits are designed to provide reasonable protection against harmful interference in a residential installation. This equipment generates uses and can radiate radio frequency energy and, if not installed and used in accordance with the instructions, may cause harmful interference to radio communications. However, there is no guarantee that interference will not occur in a particular installation. If this equipment does cause harmful interference to radio or television reception, which can be determined by tuning the equipment off and on, the user is encouraged to try to correct the interference by one or more of the following measures:

- Reorient or relocate the receiving antenna.
- Increase the separation between the equipment and receiver.
- Connect the equipment into an outlet on a circuit different from that to which the receiver is connected.
- Consult the dealer or an experienced radio/television technician for help.

Class A ITE:

Class A ITE is a category of all other ITE which satisfies the class A ITE limits but not the class B ITE limits. Such equipment should not be restricted in its sale but the following warning shall be included in the instructions for use:

Warning - This is a class A product. In a domestic environment this product may cause radio interference in which case the user may be required to take adequate measures.

CE Class A (EMC)



This product is herewith confirmed to comply with the requirements set out in the Council Directives on the Approximation of the laws of the Member States relating to Electromagnetic Compatibility Directive 2004/108/EEC.

Warning - This is a Class A product. In a domestic environment this product may cause radio interference in which case the user may be required to take adequate measures to correct this interference.

DISCLAIMER

No warranty or representation, either expressed or implied, is made with respect to the contents of this documentation, its quality, performance, merchantability, or fitness for a particular purpose. Information presented in this documentation has been carefully checked for reliability; however, no responsibility is assumed for inaccuracies. The information contained in this documentation is subject to change without notice.

In no event will AVerMedia be liable for direct, indirect, special, incidental, or consequential damages arising out of the use or inability to use this product or documentation, even if advised of the possibility of such damages.

TRADEMARKS

AVerVision is registered trademarks of AVerMedia Information, Inc. IBM PC is a registered trademark of International Business Machines Corporation. Macintosh is a registered trademark of Apple Computer, Inc. Microsoft is a registered trademark and Windows is a trademark of Microsoft Corporation. All other products or corporate names mentioned in this documentation are for identification and explanation purposes only, and may be trademarks or registered trademarks of their respective owners.

COPYRIGHT

© 2008 by AVerMedia Information, Inc. All rights reserved. No part of this publication may be reproduced, transmitted, transcribed, stored in a retrieval system, or translated into any language in any form by any means without the written permission of AVerMedia INFORMATION, Inc.



THE MARK OF CROSSED-OUT WHEELED BIN INDICATES THAT THIS PRODUCT MUST NOT BE DISPOSED OF WITH YOUR OTHER HOUSEHOLD WASTE. INSTEAD, YOU NEED TO DISPOSE OF THE WASTE EQUIPMENT BY HANDING IT OVER TO A DESIGNATED COLLECTION POINT FOR THE RECYCLING OF WASTE ELECTRICAL AND ELECTRONIC EQUIPMENT. FOR MORE INFORMATION ABOUT WHERE TO DROP OFF YOUR WASTE EQUIPMENT FOR RECYCLING, PLEASE CONTACT YOUR HOUSEHOLD WASTE DISPOSAL SERVICE OR THE SHOP WHERE YOU PURCHASED THE PRODUCT.

Table of Contents

Introduction.....	1
Package Contents	1
Optional Accessories.....	2
AVerVision CP300 Parts.....	3
Technical Specifications.....	4
Making the Connections.....	5
Connecting the Power Adapter	6
Connecting a TV	6
Connecting a VGA, Mac Display Monitor or LCD/DLP Projector	7
Connecting an IBM Compatible PC or Macintosh Computer	8
Installing the Optional Light Box	9
Connecting to a Microscope	9
Setting Up AVerVision CP300.....	10
Camera Head	10
LED & Laser Positioning Guide	10
Flexible Gooseneck and Arm.....	11
Infrared Sensor.....	11
Anti-glare Sheet.....	11
Using the Infrared Remote Control	12
Touch Button Control Panel.....	15
OSD Navigation Tree.....	17
Menu Functions.....	18
RS-232C Diagram Connection	22
RS-232C Cable Spec	22
RS-232C Transmission Spec.....	23
RS-232C Communication Format.....	23
RS-232C Command Table.....	23
Transferring the Captured Image to PC.....	24
Troubleshooting	24
Limited Warranty	25

Introduction

Thank you for purchasing the AVerMedia® AVerVision CP300. This document camera displays documents, negatives, transparencies and 3D objects onto a TV, LCD or DLP projector making presentations a snap.

AVerVision CP300 is an ideal presentation tool for business, academic, medical and the scientific community.

AVerMedia

Package Contents

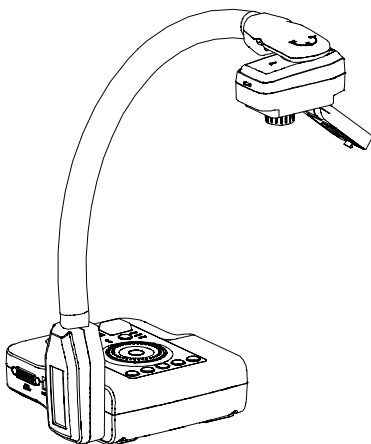

AVerMedia® AVerVision CP300

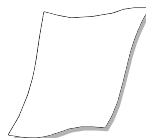

Anti-glare Sheet



Remote Control
(batteries included)



User Manual



Bag

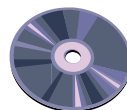

Driver CD

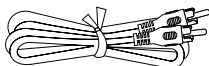

RCA Cable

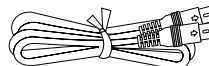

S-Video Cable

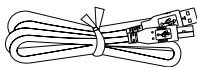

USB Cable

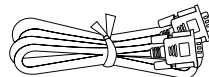

Computer Extension cable
(VGA Cable)

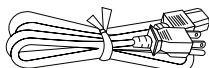

Power Cord

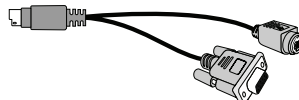

S-Video/RS-232 Cable

* The power cord will vary depending on the standard power outlet of the country where it is sold.

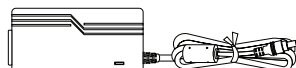

Power Adapter

Optional Accessories

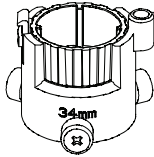

34mm Microscopic Adapter

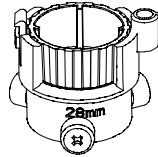

28mm Microscopic Adapter

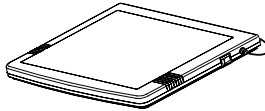

Light Box

AVerVision CP300 Parts

The illustrations below identify the parts of AVerVision CP300.

- (1) Camera head
- (2) LED light with Laser Positioning Guide
- (3) Camera lens
- (4) LED & Laser Positioning Guide switch
- (5) IR sensor
- (6) Control panel
- (7) Right panel
- (8) Gooseneck
- (9) Rear panel
- (10) Left panel
- (11) Light box power port
- (12) DC 12V port
- (13) Antitheft slot
- (14) Camera head holder
- (15) S-Video output port
- (16) Composite video output port
- (17) RGB input port
- (18) RGB output port
- (19) TV-RGB switch
- (20) USB port
- (21) DVI-I output port

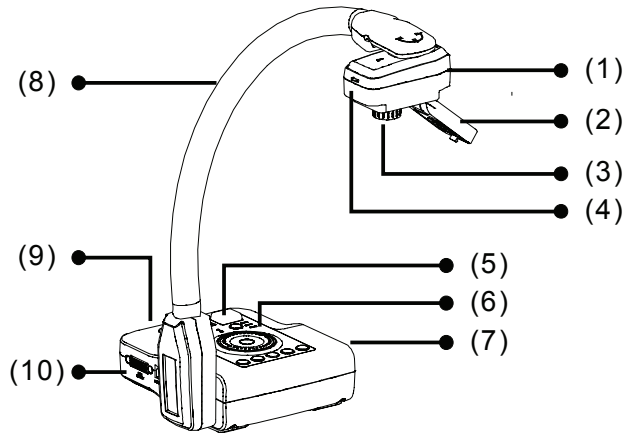

Right Panel

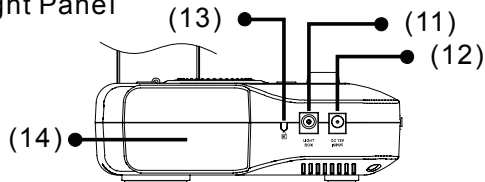

Rear Panel

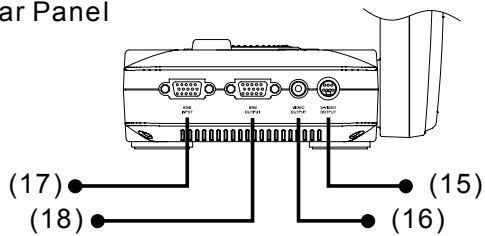

Left Panel

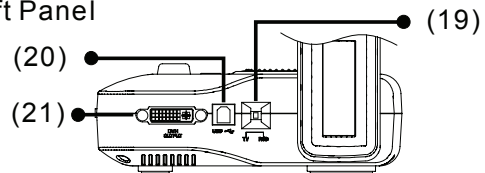

AVerMedia

Technical Specifications

Image

Sensor	1/2" Progressive Scan CMOS
Pixel Count	3.2 mega pixels
Frame Rate	24 fps (max.)
White Balance	Auto / Manual
Exposure	Auto / Manual
Image mode	Text / Graphics / High Frame
Effect	Color / B/W / Negative
Analog RGB output	WXGA 60Hz (1280 x 720); XGA 60 Hz; SVGA 60 Hz; VGA 60 Hz
Image Capture	Up to 80 Frames

Optics

Lens	F3.0; fl=9.6mm
Focusing	Auto/Manual
Shooting Area	300mm x 225mm (max.)
Zooming	2X AVERZOOM, 8X Digital Zoom

Power

Power Source	100-240V ~ 4.0-4.2A, 50-60Hz
Consumption	18 Watts (lamp off); 20 Watts (lamp on)

Lighting

Lamp Type	LED light with laser pointer
-----------	------------------------------

Input/Output

RGB Input	15-Pins D-sub (VGA)
RGB Output	15-Pins D-sub (VGA)
DVI-I Output	DVI-I Type
S-Video	Mini-DIN Jack
Composite Video	RCA Jack
USB	USB2.0
DC 12V Input	Power Jack
Light Box	Power Jack (DC 6V Output)

Dimension

Operating	160mm x 170mm x 450mm
Folded	287.4mm x 232.5mm x 61mm
Weight	2.4 kg (about 5.3 lb)

Making the Connections

The ports on the rear, left and right panel of CP300 enable you to connect the unit to a computer, graphics display monitor or LCD/DLP projector, TV or other device. Illustrated below are the ports that are located at the rear, left and right panel of CP300 with their corresponding labels.

Right Panel

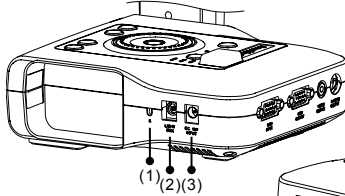

Rear & Left Panel

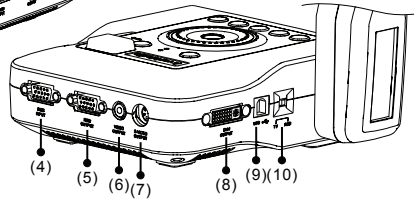

Port	Description
(1) Antitheft Slot	Attach a Kensington compatible security lock or antitheft device.
(2) Light Box	Plug the optional light box into this port.
(3) DC 12V Input	Connect the power adapter into this port.
(4) RGB INPUT	Input the signal from a computer or other sources and pass it through to the RGB Output port only. Connect this port to the VGA output port of the computer.
(5) RGB OUTPUT	Output the signal from the camera, RGB input port, or the captured images from the memory on a VGA/Mac monitor or LCD/DLP projector.
(6) VIDEO OUTPUT (RCA/Composite)	Output the signal from the camera or the captured images from the memory on TV or Video equipment.
(7) S-VIDEO OUTPUT	Output the signal from the camera or the captured images from the memory on TV or Video equipment.
(8) DVI-I OUTPUT	Output the signal from the camera, RGB input port, or the captured images from the memory on a VGA/Mac monitor or LCD/DLP projector with DVI-I interface. If the display device does not support DVI-I, it can only display the signal from the camera and the captured images.

Port	Description
(9) USB	Use CP300 as a USB Camera or transfer the captured images from CP300 memory to PC.
(10)TV-RGB switch	Switch to output display video either from Video and S-VIDEO, or RGB and DVI-I output port.

Connecting the Power Adapter

Connect the power adapter to a standard 100V~240V AC power source.

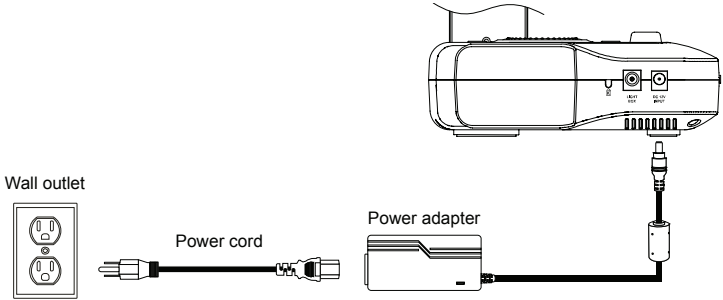

Connecting a TV

Locate the VIDEO, S-VIDEO or SCART RGB input port of the TV or Video equipment (i.e., VCR) to record your presentation on a videotape and connect it to S-VIDEO or VIDEO OUTPUT port of CP300. If you are not sure, please refer to the user manual of the TV or Video equipment.



For better video quality, we strongly suggest using S-VIDEO connection.

Make sure the TV/RGB switch is set to TV.

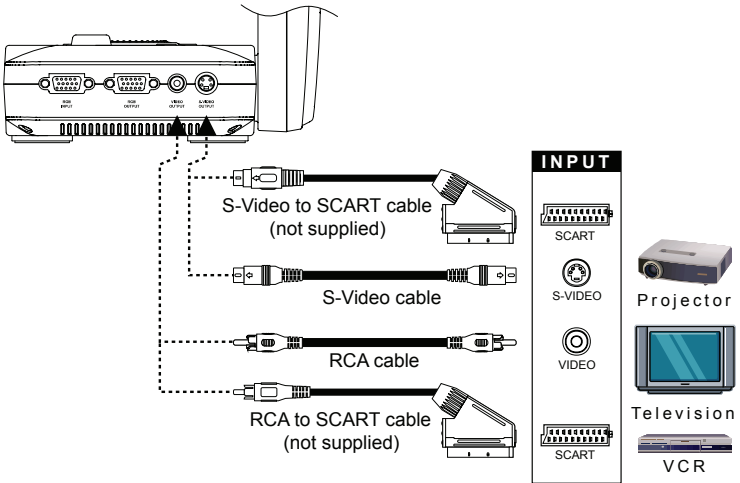

Connecting a VGA, Mac Display Monitor or LCD/DLP Projector

Locate the RGB (VGA) input port of the display device and connect it to RGB OUTPUT port of CP300. If you are not sure, please refer to the user manual of the device.



Make sure the TV/RGB switch is set to RGB.

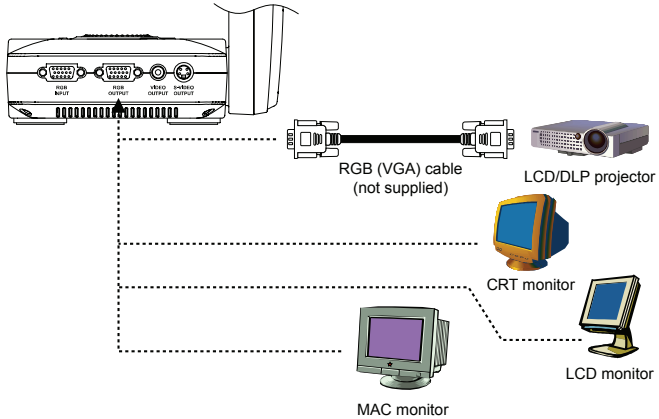

Connecting a VGA Monitor or LCD/DLP Projector with DVI interface

Locate the DVI input port of the display device and connect it to DVI-I OUTPUT port of CP300. If you are not sure, please refer to the user manual of the device.



Make sure the TV/RGB switch is set to RGB.

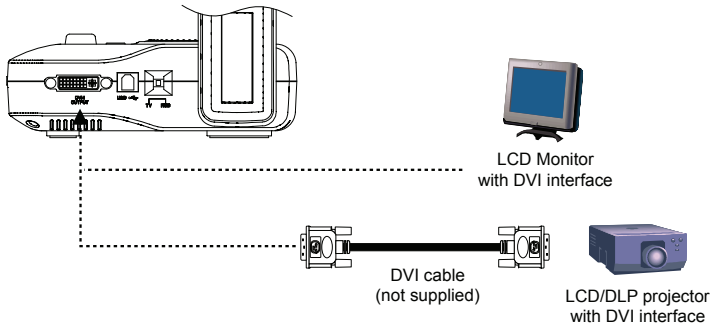

Connecting an IBM Compatible PC or Macintosh Computer

Locate the RGB (VGA) output port of the computer or laptop to display your PC presentation on screen and connect it to RGB INPUT port of CP300. The video signal from the RGB INPUT port is streamed to RGB and DVI-I OUTPUT port, and displayed on the screen.

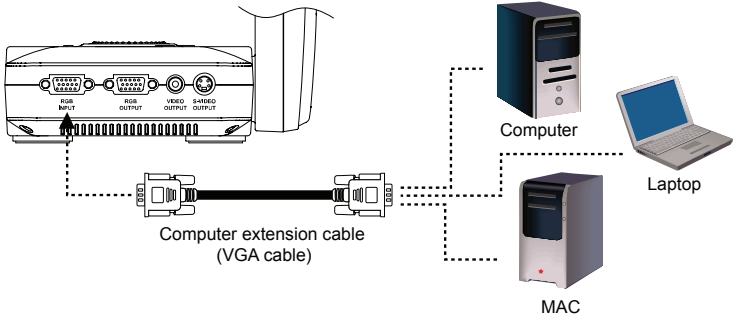

Connecting a Computer via USB Connection

Locate the USB port of the computer or laptop and connect it to USB port of CP300. This enables you to use CP300 as a USB Camera and to transfer the captured images from the memory and to computer. Also see "Transfer Image from AVerVision CP300 to PC".

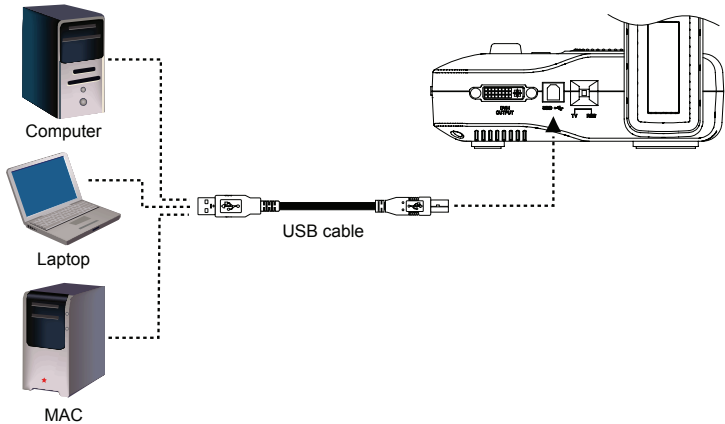

Installing the Optional Light Box

Connecting an optional light box enables you to view x-rays, transparencies and negative slides.

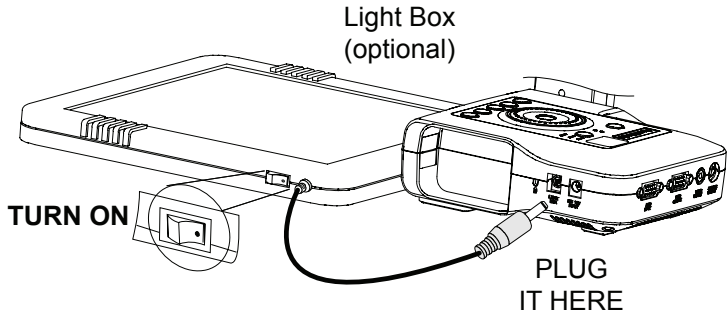

Connecting to a Microscope

Connecting the CP300 to a microscope enables you to examine microscopic objects on a big screen without straining your eyes.

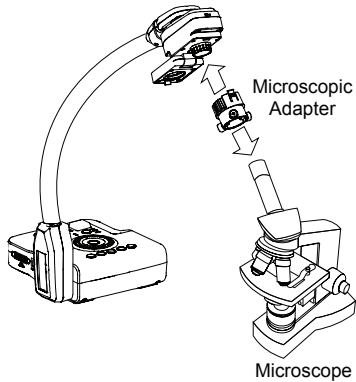

Setting Up AVerVision CP300

This section provides useful tips on how to adjust the CP300 to meet your needs.

Camera Head

The camera head can be turned 90 ° to the left and right. The latch must be pressed to open and unfold the LED light.



Make sure to unfold the LED light fully.

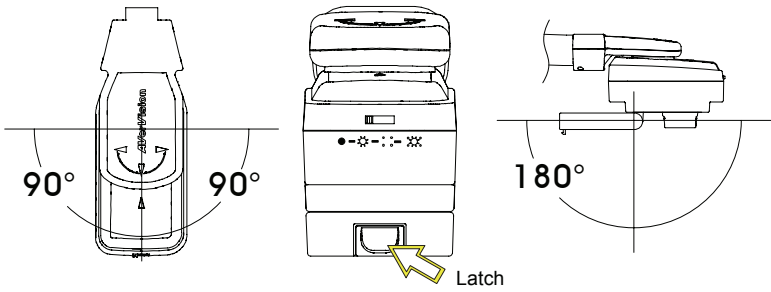

LED & Laser Positioning Guide

A unique feature of the CP300 is the four (4) laser positioning pointers that define the viewing area. This enables the user to quickly center the object underneath the camera. The three (3) various light and laser positioning pointers settings are provided as follows:

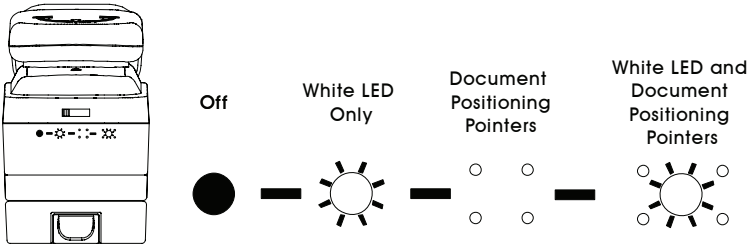

Flexible Gooseneck and Arm

The flexible gooseneck and arm design allows you to position the camera head from any angle.

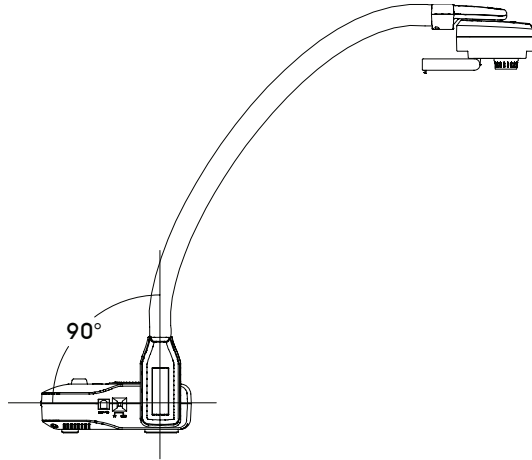

Infrared Sensor

Aim the remote control at the infrared sensor to operate the unit.

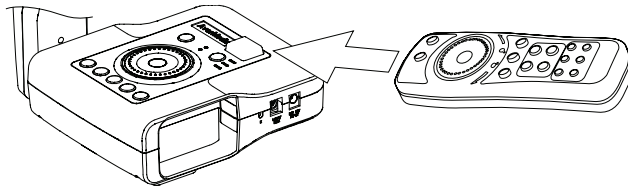

Anti-glare Sheet

The anti-glare sheet is a special coated film that helps eliminate any glare that maybe encountered while displaying very shiny objects or glossy surfaces such as magazines and pictures. To use, simply place the anti-glare sheet on top of the shiny document to reduce reflected light.

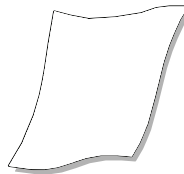

Using the Infrared Remote Control

Use the CP300 Remote Control to enhance your presentation by having the ability to switch between three (3) presentation modes and access various features. To use the remote control, first insert the batteries (2 “AAA” size batteries are provided) into the battery compartment at the back of the remote. Use the figure and descriptions below as a reference for remote control functions.

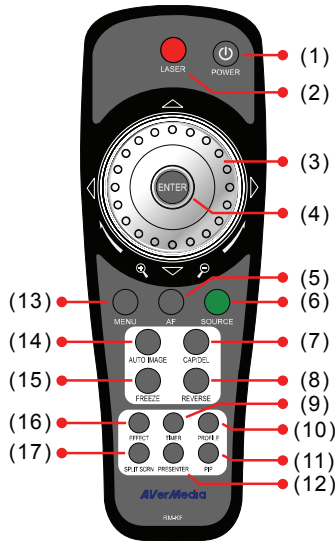

Name	Function
(1) POWER	Turn the unit on/off.
(2) LASER	Turn on the laser pointer.
 DO NOT look directly at the laser pointer and avoid aiming the laser at any surface that may reflect the beam (i.e., a mirror or mirrored surface).	
(3) Shuttle Wheel	<ul style="list-style-type: none"> - Turn the shuttle wheel clockwise to zoom in and counter-clockwise to zoom out the image in Camera and Playback mode only. When it reaches the maximum AVERZOOM level of about 200%, you can still continue to digitally zoom in the image up to 1600%. Press ENTER to return to normal view (100%). - Press the shuttle wheel ▲, ▼, ◀, & ▶ to pan the image while in zoom in mode, to make a selection on 16-thumbnail images or move to the next or previous single full screen preview in Playback mode, or to

Name	Function
(3) Shuttle Wheel	make a selection or adjustment on the OSD main-menu and sub-menu (See Menu Functions for more details).
(4) ENTER	Make a selection in Playback mode and OSD menu.
(5) AF (Auto Focus)	Adjust the focus automatically.
(6) Source	<p>Switch between Camera, Playback and PC mode.</p> <ul style="list-style-type: none"> - Camera mode displays the video signal from the built-in camera. - Playback mode displays the captured image from the built-in memory in 16-thumbnail images. Use ▲, ▼, ◀, & ▶ buttons to make a selection and ENTER to display the selected image in full screen. To start slide show, press MENU, select START and press ENTER to begin and end. Select INTERVAL to set the display time interval between frames in second. - PC mode displays the video signal from the RGB INPUT port of CP300.
(7) CAP/DEL	<ul style="list-style-type: none"> - Capture a still image in Camera mode. The captured image is saved in the built-in memory at 1024 x 768 resolution and can store up to 80 images. - Remove the selected picture from the built-in memory permanently in Playback mode.
(8) REVERSE	Rotate the image by 180° in Camera mode only.
(9) TIMER	Display the OSD timer menu and use ▲ or ▼ buttons to select SET TIME to set the time value, START to begin the countdown timer, PAUSE/RESUME to temporarily halt or continue, and STOP to end.
(10) PROFILE	Recall and switch from the 3 saved user setting profile selections (See MENU Functions – SAVE for more details).
(11) PIP	<p>Display/hide a thumbnail of the captured image from the memory source at the corner of the screen while in Camera mode.</p> <p>Use ◀ or ▶ buttons to move to the previous or next image and ENTER to display the image in full screen. To move the mini playback screen to different corners, press MENU, go to PIP and select the position of the mini playback screen.</p>
(12) PRESENTER	<p>Select to turn on/off AVerBox or AVerVisor. Only one feature can be used at a time.</p> <p>AVerBox overlays a frame on the presentation screen. Selecting SHADE changes the opacity of the area outside the box from 0%, 50% and 100%, COLOR to</p>

Name	Function
------	----------

(12) PRESENTER change the frame color from red, green and blue, and **RESIZE** to change the size of the frame. To resize or move the frame around the presentation screen, press the shuttle wheel ▲, ▼, ◀, & ▶.

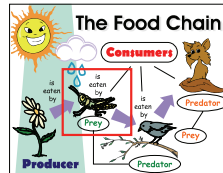

AVerVisor covers part of the presentation screen. The upper part of the presentation screen is slightly exposed when it is being called each time. To expose part of the covered area, press the shuttle wheel ▲, ▼, ◀, & ▶. Select **SHADE** to change the darkness of the shaded area between 50% or 100%.

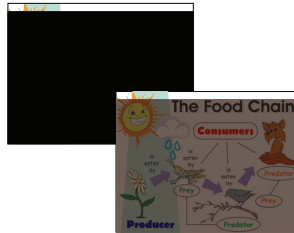

(13) MENU Pull up and exit the OSD main-menu and sub-menu.

(14) AUTO IMAGE Automatically adjust and set the white balance and exposure setting.

(15) FREEZE Toggle to pause or resume the camera.

(16) EFFECT Convert and display the image in BW, Negative or Color in Camera and Playback mode only.

(17) SPLIT SCR N Turn on/off split screen mode. Split Screen divides the screen into two parts. One side displays the live image from the CP300 camera and the other side displays the captured images from the memory source in 8-thumbnail preview.

Use the ▲, ▼, ◀, & ▶ buttons to make a selection and **ENTER** to enlarge the selected image in split screen mode. To horizontally or vertically pan the enlarged image, use the ◀ & ▶ or ▲ & ▼ buttons. To switch to different split screen type, press **MENU**, go to **SPLIT SCREEN** and select between vertical or horizontal splitting type.

Touch Button Control Panel

The touch button control panel located on the top side of the CP300 provides quick access to commonly used functions.

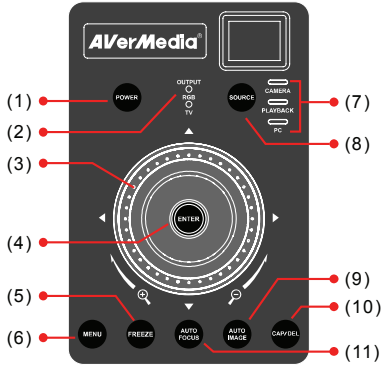

Function	Description
(1) POWER	Turn the unit on/off.
(2) Output LED Indicator	Indicate the setting of the TV to RGB dip switch to which the video signal is being sent out.
(3) Shuttle Wheel	<ul style="list-style-type: none"> - Turn the shuttle wheel clockwise to zoom in and counter-clockwise to zoom out the image in Camera and Playback mode only. <p>When it reaches the maximum AVERZOOM level of about 200%, you can still continue to digitally zoom in the image up to 1600%. Press ENTER to return to normal view (100%).</p> <ul style="list-style-type: none"> - Press the shuttle wheel ▲, ▼, ◀, & ▶ to pan the image while in zoom in mode, to make a selection on 16-thumbnail images or move to the next or previous single full screen preview in Playback mode, or to make a selection and adjustment on the OSD main-menu and sub-menu (See Menu Functions for more details).
(4) ENTER	Make a selection in Playback mode and OSD menu.
(5) FREEZE	Toggle to pause or resume the camera.
(6) MENU	Pull up and exit the OSD main-menu and sub-menu.
(7) Source LED Indicator	Indicate the source of the video signal or image.

Function	Description
(8) Source 	Switch between Camera, Playback and PC mode. <ul style="list-style-type: none"> - Camera mode displays the video signal from the built-in camera. - Playback mode displays the captured image from the built-in memory in 16-thumbnail images. Use ▲, ▼, ◀, & ▶ buttons to make a selection and ENTER to display the selected image in full screen. To start slide show, press MENU, select START and press ENTER to begin and end. Select INTERVAL to set the display time interval between frames in second. - PC mode displays the video signal from the RGB INPUT port of CP300.
(9) AUTO IMAGE	Automatically adjust and set the white balance and exposure setting.
(10) CAP/DEL	<ul style="list-style-type: none"> - Capture a still image in Camera mode. The captured image is saved in the built-in memory at 1024 x 768 resolution and can store up to 80 images. - Remove the selected picture from the built-in memory permanently in Playback mode.
(11) AUTO FOCUS	Adjust the focus automatically.

OSD Navigation Tree

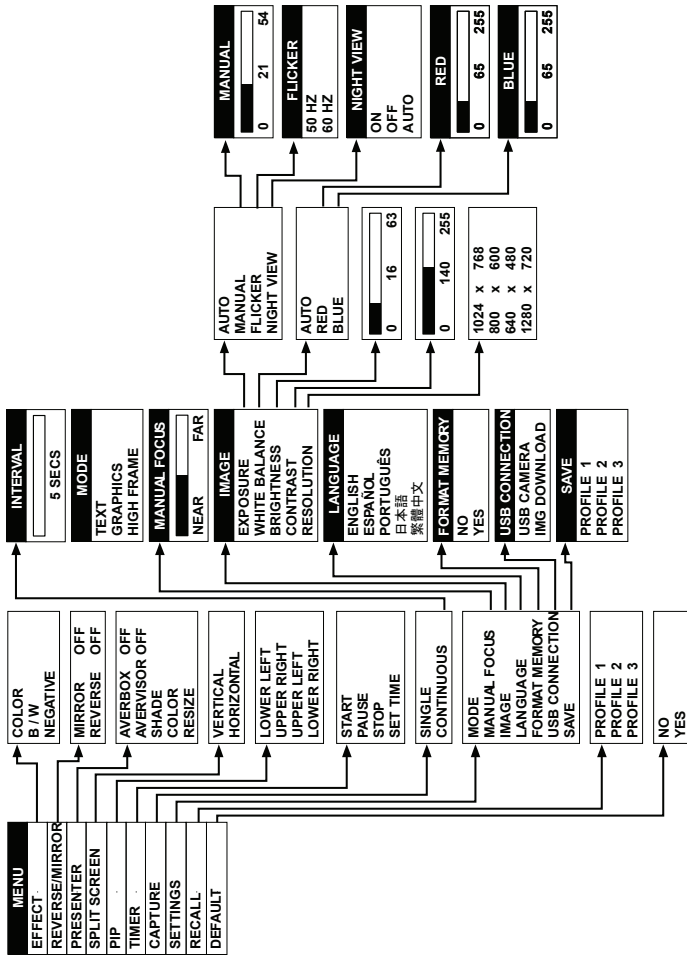

Menu Functions

The MENU functions of CP300 enhance fine-tuning your screen display, set the timer, select OSD language and more. Press the **MENU** button to call up and exit from the main menu or sub-menu display. Then use **▲** or **▼** buttons to select the items in the menu list. Use **▶/ENTER** button to enter sub-menu and **◀/ENTER** to return to main menu. To adjust the setting, press **◀** or **▶** buttons. To make a selection, press **ENTER**.

OSD Menu	Description																						
<table border="1"> <tr><td colspan="2">MENU</td></tr> <tr><td>EFFECT</td><td>COLOR</td></tr> <tr><td>REVERSE/MIRROR</td><td>B / W</td></tr> <tr><td>PRESENTER</td><td>NEGATIVE</td></tr> <tr><td>SPLIT SCREEN</td><td></td></tr> <tr><td>PIP</td><td></td></tr> <tr><td>TIMER</td><td></td></tr> <tr><td>CAPTURE</td><td></td></tr> <tr><td>SETTINGS</td><td></td></tr> <tr><td>RECALL</td><td></td></tr> <tr><td>DEFAULT</td><td></td></tr> </table>	MENU		EFFECT	COLOR	REVERSE/MIRROR	B / W	PRESENTER	NEGATIVE	SPLIT SCREEN		PIP		TIMER		CAPTURE		SETTINGS		RECALL		DEFAULT		<p>EFFECT</p> <p>Press ▶ and use ▲ or ▼ buttons to select and display the image in Camera mode into positive (true color), monochrome (black and white) or negative. Then press ▶/ENTER to make a selection.</p>
MENU																							
EFFECT	COLOR																						
REVERSE/MIRROR	B / W																						
PRESENTER	NEGATIVE																						
SPLIT SCREEN																							
PIP																							
TIMER																							
CAPTURE																							
SETTINGS																							
RECALL																							
DEFAULT																							
<table border="1"> <tr><td colspan="2">MENU</td></tr> <tr><td>EFFECT</td><td></td></tr> <tr><td>REVERSE/MIRROR</td><td>MIRROR OFF</td></tr> <tr><td>PRESENTER</td><td>REVERSE OFF</td></tr> <tr><td>SPLIT SCREEN</td><td></td></tr> <tr><td>PIP</td><td></td></tr> <tr><td>TIMER</td><td></td></tr> <tr><td>CAPTURE</td><td></td></tr> <tr><td>SETTINGS</td><td></td></tr> <tr><td>RECALL</td><td></td></tr> <tr><td>DEFAULT</td><td></td></tr> </table>	MENU		EFFECT		REVERSE/MIRROR	MIRROR OFF	PRESENTER	REVERSE OFF	SPLIT SCREEN		PIP		TIMER		CAPTURE		SETTINGS		RECALL		DEFAULT		<p>REVERSE / MIRROR</p> <p>Press ▶ and use ▲ or ▼ buttons to select and turn on MIRROR to flip the image and REVERSE to rotate the image by 180° in Camera mode. Then press ▶/ENTER to make a selection.</p>
MENU																							
EFFECT																							
REVERSE/MIRROR	MIRROR OFF																						
PRESENTER	REVERSE OFF																						
SPLIT SCREEN																							
PIP																							
TIMER																							
CAPTURE																							
SETTINGS																							
RECALL																							
DEFAULT																							
<table border="1"> <tr><td colspan="2">MENU</td></tr> <tr><td>EFFECT</td><td></td></tr> <tr><td>REVERSE/MIRROR</td><td></td></tr> <tr><td>PRESENTER</td><td>AVERBOX OFF</td></tr> <tr><td>SPLIT SCREEN</td><td>AVERVISOR OFF</td></tr> <tr><td>PIP</td><td></td></tr> <tr><td>TIMER</td><td></td></tr> <tr><td>CAPTURE</td><td></td></tr> <tr><td>SETTINGS</td><td></td></tr> <tr><td>RECALL</td><td></td></tr> <tr><td>DEFAULT</td><td></td></tr> </table>	MENU		EFFECT		REVERSE/MIRROR		PRESENTER	AVERBOX OFF	SPLIT SCREEN	AVERVISOR OFF	PIP		TIMER		CAPTURE		SETTINGS		RECALL		DEFAULT		<p>PRESENTER</p> <p>Press ▶ and use ▲ or ▼ buttons to select and turn on either AVERBOX or AVERVISOR. Then press ▶/ENTER to make a selection. Only one feature can be used at a time.</p> <p>AVerBox overlays a frame on the presentation screen. Selecting SHADE changes the opacity of the area outside the box from 0%, 50% and 100%, COLOR to change the frame color from red, green and blue, and RESIZE to change the size of the frame. To resize or move the frame around the presentation screen, press the shuttle wheel ▲, ▼, ◀, & ▶.</p>
MENU																							
EFFECT																							
REVERSE/MIRROR																							
PRESENTER	AVERBOX OFF																						
SPLIT SCREEN	AVERVISOR OFF																						
PIP																							
TIMER																							
CAPTURE																							
SETTINGS																							
RECALL																							
DEFAULT																							

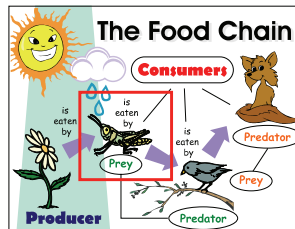

OSD Menu

Description

MENU	
EFFECT	
REVERSE/MIRROR	
PRESENTER	
SPLIT SCREEN	AVERBOX OFF
PIP	AVERVISOR OFF
TIMER	SHADE
CAPTURE	SHADE
SETTINGS	SHADE
RECALL	SHADE
DEFAULT	SHADE

AVerVisor covers part of the presentation screen. The upper part of the presentation screen is slightly exposed when it is being called each time. To expose part of the covered area, press the shuttle wheel ▲, ▼, ◀, & ▶. Select **SHADE** to change the darkness of the shaded area between 50% or 100%.



MENU	
EFFECT	
REVERSE/MIRROR	
PRESENTER	
SPLIT SCREEN	VERTICAL
PIP	HORIZONTAL
TIMER	
CAPTURE	
SETTINGS	
RECALL	
DEFAULT	

SPLIT SCREEN

Press ▶ and use ▲ or ▼ buttons to select dividing the screen either vertically or horizontally. Then press ▶/ENTER to make a selection.

This function divides the screen into two parts. One side displays the live image from the CP300 camera and the other side displays the captured images from the memory source in 8-thumbnail preview.

Use the ▲, ▼, ◀, & ▶ buttons to make a selection and **ENTER** to enlarge the selected image in split screen mode. To horizontally or vertically pan the enlarged image, use the ◀ & ▶ or ▲ or ▼ buttons.

MENU	
EFFECT	
REVERSE/MIRROR	
PRESENTER	
SPLIT SCREEN	
PIP	LOWER LEFT
TIMER	UPPER RIGHT
CAPTURE	UPPER LEFT
SETTINGS	LOWER RIGHT
RECALL	
DEFAULT	

PIP

Press ▶ and use ▲ or ▼ buttons to select the location of the mini playback screen. Then press ▶/ENTER to make a selection.

Display a thumbnail of the captured image from the memory source at the corner of the screen while in Camera mode.

Use ◀ or ▶ buttons to move to the previous or next image and **ENTER** to display the image in full screen.

MENU	
EFFECT	
REVERSE/MIRROR	
PRESENTER	
SPLIT SCREEN	
PIP	
TIMER	START
CAPTURE	PAUSE
SETTINGS	RESUME
RECALL	STOP
DEFAULT	SET TIME

TIMER

Press ▶ and use ▲ or ▼ buttons to select **SET TIME** to set the time value, **START** to begin the countdown timer, **PAUSE/RESUME** to temporarily halt or continue, and **STOP** to end.

MENU	
EFFECT	
REVERSE/MIRROR	
PRESENTER	
SPLIT SCREEN	
PIP	
TIMER	
CAPTURE	SINGLE
SETTINGS	CONTINUOUS
RECALL	
DEFAULT	

CAPTURE

Press ▶ and use ▲ or ▼ buttons to select **SINGLE** or **CONTINUOUS** capture mode. Then press ▶/ENTER to make a selection.

Setting **SINGLE** saves one still image only and **CONTINUOUS** saves successive still images until the built-in memory is full or when the **CAP/DEL** button is being press again to stop.

OSD Menu	Description
----------	-------------



In Continuous mode, use ► or ◀ buttons to increase or decrease the capture time interval between frames and then press **ENTER** to save the setting and exit. The time interval can be set from 5 to 600 sec.

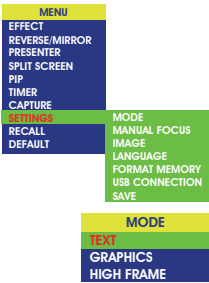

SETTINGS
Press ►, then use ▲ or ▼ buttons to select the items in **SETTINGS** list and press ►/ENTER.

SETTINGS > MODE

Use ▲ or ▼ buttons to select between Text, Graphics and High Frame enhancement mode and then **ENTER** to make a selection.

- Text - corrects the intensity of the adjacent pixel making it more uniform producing sharper and clearer images.
- Graphics - adjusts the gradient of the adjacent pixel making it appears to have a smooth image.
- High Frame - increases the frame rate capture and can visually tracks the motion and react quickly. Sufficient lighting is required when using this mode.



SETTINGS > MANUAL FOCUS

Use ◀ or ► buttons to manually adjust the focus and then press **ENTER** to save the setting and exit.



SETTINGS > IMAGE > EXPOSURE

Press ► and use ▲ or ▼ buttons to select between Auto, Manual, Flicker and Night View. Then press ►/ENTER to make a selection.

Select **AUTO** to automatically adjust the camera exposure to determine how much light is required.



SETTINGS > IMAGE > EXPOSURE > MANUAL

Use ► or ◀ buttons to manually adjust the exposure level then press **ENTER** to save the setting and exit.







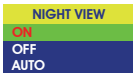



SETTINGS > IMAGE > EXPOSURE > FLICKER

Use ▲ or ▼ buttons to select between 50Hz or 60Hz. Some display devices cannot handle high refresh rates. The image will flicker a couple of times as the output is switched to another refresh rate.

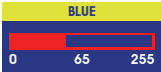

SETTINGS > IMAGE > EXPOSURE > NIGHT VIEW

Use ▲ or ▼ buttons to turn Night View **OFF** or **AUTO**. If you are presenting in a low-light condition, Night View enables the image of the object to appear as though under normal lighting conditions. CP300 can

OSD Menu	Description
	<p>automatically adjust the exposure to compensate for the adverse condition, but the captured image will appear to be in slow motion.</p>
	<p>SETTINGS > IMAGE > EXPOSURE > WHITE BALANCE</p> <p>Press ▶ and use ▲ or ▼ buttons to select between auto or manually adjust the red and blue color to suit the lighting condition or color temperature. Then press ▶/ENTER to make a selection.</p>
	<p>SETTINGS > IMAGE > EXPOSURE > WHITE BALANCE > RED</p> <p>Use ▶ or ◀ buttons to manually adjust the red color level then press ENTER to save the setting and exit.</p>
	<p>SETTINGS > IMAGE > EXPOSURE > WHITE BALANCE > BLUE</p> <p>Use ▶ or ◀ buttons to manually adjust the blue color level then press ENTER to save the setting and exit.</p>
	<p>SETTINGS > IMAGE > BRIGHTNESS</p> <p>Use ▶ or ◀ buttons to increase or decrease the brightness level and improve the visibility of the image. The brightness level can be set up to 63.</p>
	<p>SETTINGS > IMAGE > CONTRAST</p> <p>Use ▶ or ◀ buttons to emphasize or reduce the difference between light and dark conditions. The contrast level can be adjustable up to 255.</p>
	<p>SETTINGS > IMAGE > RESOLUTION</p> <p>Press ▶ and use ▲ or ▼ buttons to choose from different display resolutions then press ▶/ENTER to make the selection.</p> <p>This selection will not be available in TV output (Composite/S-Video)</p>
	<p>SETTINGS > LANGUAGE</p> <p>Use ▲ or ▼ buttons to select from different languages then press ▶/ENTER to make the selection.</p>
	<p>SETTINGS > FORMAT MEMORY</p> <p>Use ▲ or ▼ buttons to select NO to exit or YES to format and delete all the images saved in the built-in memory then press ▶/ENTER.</p> <p>Please wait till the message “FORMAT” disappear to finish the process.</p>
	<p>SETTINGS > USB SELECT</p> <p>Use ▲ or ▼ buttons to select the USB function between USB Camera and Img Download.</p> <ul style="list-style-type: none"> • USB Camera - can be used as a computer webcam or with our bundled software as video recorder and capture still image.

OSD Menu	Description
<ul style="list-style-type: none"> USB CONNECTION USB CAMERA IMG DOWNLOAD 	<ul style="list-style-type: none"> • Img Download - transfer the captured images from the built-in memory to computer hard disk.
<ul style="list-style-type: none"> SAVE PROFILE 1 PROFILE 2 PROFILE 3 	<p>SETTINGS > SAVE</p> <p>Use ▲ or ▼ buttons to select which user setting profile number to save your preferred setting. Only effect, mode, brightness and contrast settings can be saved.</p>
<ul style="list-style-type: none"> MENU EFFECT REVERSE/MIRROR PRESENTER SPLIT SCREEN PIP TIMER CAPTURE SETTINGS RECALL DEFAULT 	<p>RECALL</p> <p>Press ► and use ▲ or ▼ buttons to select from the list to change to the preferred saved user setting profile number then press ►/ENTER to make the selection.</p>
<ul style="list-style-type: none"> MENU EFFECT REVERSE/MIRROR PRESENTER SPLIT SCREEN PIP TIMER CAPTURE SETTINGS RECALL DEFAULT 	<p>DEFAULT</p> <p>Press ► and use ▲ or ▼ buttons to select YES to restore to original factory default setting or NO to exit then press ►/ENTER to make the selection.</p>

RS-232C Diagram Connection

CP300 can be controlled using a PC through RS-232 connection.

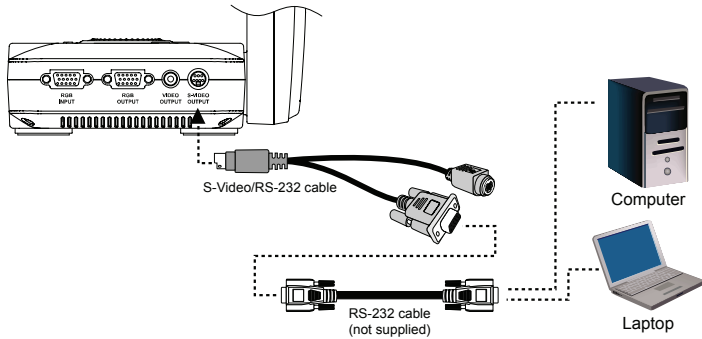

RS-232C Cable Spec

Make sure the RS-232 cable matches the cable spec design.

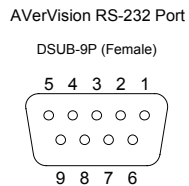
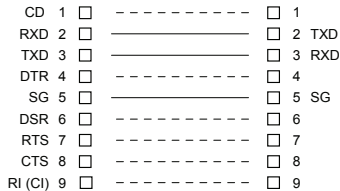
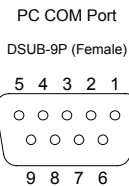

RS-232C Transmission Spec

- Star bit : 1 bit
- Data bit : 8 bit
- Stop bit : 1 bit
- Parity bit : None
- X parameter : None
- Baud rate(Communication speed) : 9600bps

RS-232C Communication Format

Start Code(1 Byte) : 0xFF
 Type Code(1 Byte) : 0x70
 DataLength Code(1 Byte) : 0x01
 Data Code(1 Byte) : See the Command Table for reference.
 CheckSum Code(1 Byte) : See the Command Table for reference.
 Format : Start + Type + DataLength + Data + CheckSum
 Example : 0xFF + 0x70 + 0x01+ 0x1 + 0x70 (Command Power)

RS-232C Command Table

FUNCTION	DATA CODE	CHECKSUM CODE
POWER	0x1	0x70
ENTER	0x2	0x73
UP	0x3	0x72
DOWN	0x4	0x75
LEFT	0x5	0x74
RIGHT	0x6	0x77
MENU	0x7	0x76
AUTOFOCUS	0x8	0x79
SOURCE	0x9	0x78
AUTO IMAGE	0xA	0x7B
CAPTURE	0xB	0x7A
FREEZE	0xC	0x7D
REVERSE	0xD	0x7C
EFFECT	0xE	0x7F
TIMER	0xF	0x7E
RECALL	0x10	0x61
SPLIT SCRNR	0x11	0x60
PRESENTER	0x12	0x63
PIP	0x13	0x62

Transferring the Captured Image to PC

This enables you to transfer the captured image from the built-in memory to PC.



The instruction below **MUST** be read and followed **BEFORE** connecting the USB cable.

1. **MUST** set the USB CONNECTION as IMG DOWNLOAD before connecting the USB cable.

To set the USB CONNECTION as IMG DOWNLOAD, press **MENU** > select **SETTING** and press **▶**, select **USB CONNECTION** and press **▶**, select **IMG DOWNLOAD** and press **▶/ENTER**, and **MENU** to close the OSD menu.

2. When “IMG DOWNLOAD” appears at the lower right corner of the presentation screen, you may now connect the USB cable.
3. Upon connecting the USB cable, the system automatically detects the new removable disk. You may now transfer the captured image(s) from the CP300 built-in memory to PC hard disk.

Troubleshooting

This section provides many useful tips on how to solve common problems while using the CP300.

There is no picture on the presentation screen.

1. Check all the connectors again as shown in this manual.
2. Check the on/off switch of the display output device.
3. Verify the setting of the display output device.
4. If you are presenting from a notebook or computer through the display output device, please check the connection and switch the document camera source to PC Mode.

I have set up the CP300 and checked all the connections as specified in the manual but I cannot get a picture on the preferred presentation screen.

1. The unit POWER button turns orange in standby mode. Press the POWER button again to turn on and the LED light will turn blue.
2. The default camera display resolution setting is on 1024x768. If your output device does not support this resolution; no image can be projected. Simply press hold the MENU and **▶** button to the change the resolution setting.
3. If your display output device is on TV or any analog device, please switch the TV-RGB dip switch to TV.

The picture on the presentation screen is distorted or the image is blurry.

1. Reset all changed settings, if any, to the original manufacturer default setting (Refer to the Menu Functions for more details and steps).
2. Use the Brightness and Contrast menu functions to reduce the distortion if applicable.
3. If you discover that the image is blurry or out of focus, press the Auto Focus button on the control panel or remote control.

There is no computer signal on presentation screen.

1. Check all the cable connections among the display device, CP300 and your PC.
2. Connect your PC to the CP300 first before you power on your computer.
3. Make sure to switch your laptop to output display on external display device.

The presentation screen does not show the exact desktop image on my PC or Notebook after I toggle from Camera to PC mode.

1. Return to your PC or Notebook, place the mouse on the desktop and right click, choose "Properties", choose "Setting" tab, click on "2" monitor and check the box "Extend my Windows desktop onto this monitor".
2. Then go back one more time to your PC or Notebook and place the mouse on the desktop and right click again.
3. This time choose "Graphics Options", then "Output To", then "Intel® Dual Display Clone", and then choose "Monitor + Notebook".
4. After you follow these steps, you should be able to see the same desktop image on your PC or Notebook as well as on the presentation screen.

How do I download images from CP300 to a computer ? Is it normal that CP300 will reset to camera mode after I download images and disconnect the USB cable?

Choose "IMG Download" from the Menu, and then connect the USB cable to transfer the captured images from the CP300 to the computer. When finished, unplug the USB cable. The CP300 will automatically reset and switch to camera mode.

Limited Warranty

For a period of time beginning on the date of purchase of the applicable product and extending as set forth in the "**Warranty Period of AVerMedia Product Purchased**" section of the warranty card, AVerMedia Information, Inc. ("AVerMedia") warrants that the applicable product ("Product") substantially conforms to AVerMedia's documentation for the product and that its manufacture and components are free of defects in material and workmanship under normal use. "You" as used in this agreement means you individually or the business entity on whose behalf you use or install the product, as applicable. This limited warranty extends only to You as the original purchaser. Except for the foregoing, the Product is provided "AS IS." In no event does AVerMedia warrant that You will be able to operate the Product without problems or interruptions, or that the Product is suitable for your purposes. Your exclusive remedy and the entire liability of AVerMedia under this paragraph shall be, at AVerMedia's option, the repair or replacement of the Product with the same or a comparable product. This warranty does not apply to (a) any Product on which the serial number has been defaced, modified, or removed, or (b) cartons, cases, batteries, cabinets, tapes, or accessories used with this product. This warranty does not apply to any Product that has suffered damage, deterioration or malfunction due to (a) accident, abuse, misuse, neglect, fire, water, lightning, or other acts of nature, commercial or industrial use, unauthorized product modification or failure to follow instructions included with the Product, (b) misapplication of service by someone other than the manufacturer's representative, (c) any shipment damages (such claims must be made with the carrier), or (d) any other causes that do not relate to a Product defect. The Warranty Period of any repaired or replaced Product shall be the longer of (a) the original Warranty Period or (b) thirty (30) days from the date of delivery of the repaired or replaced product.

Limitations of Warranty

AVerMedia makes no warranties to any third party. You are responsible for all claims, damages, settlements, expenses, and attorneys' fees with respect to claims made against You as a result of Your use or misuse of the Product. This warranty applies only if the Product is installed, operated, maintained, and used in accordance with AVerMedia specifications. Specifically, the warranties do not extend to any failure caused by (i) accident, unusual physical, electrical, or electromagnetic stress, neglect or misuse, (ii) fluctuations in electrical power beyond AVerMedia specifications, (iii) use of the Product with any accessories or options not furnished by AVerMedia or its authorized agents, or (iv) installation, alteration, or repair of the Product by anyone other than AVerMedia or its authorized agents.

Disclaimer of Warranty

EXCEPT AS EXPRESSLY PROVIDED OTHERWISE HEREIN AND TO THE MAXIMUM EXTENT PERMITTED BY APPLICABLE LAW, AVERMEDIA DISCLAIMS ALL OTHER WARRANTIES WITH RESPECT TO THE PRODUCT, WHETHER EXPRESS, IMPLIED, STATUTORY OR OTHERWISE, INCLUDING WITHOUT LIMITATION, SATISFACTORY QUALITY, COURSE OF DEALING, TRADE USAGE OR PRACTICE OR THE IMPLIED WARRANTIES OF MERCHANTABILITY, FITNESS FOR A PARTICULAR PURPOSE OR NONINFRINGEMENT OF THIRD PARTY RIGHTS.

Limitation of Liability

IN NO EVENT SHALL AVERMEDIA BE LIABLE FOR INDIRECT, INCIDENTAL, SPECIAL, EXEMPLARY, PUNITIVE, OR CONSEQUENTIAL DAMAGES OF ANY NATURE INCLUDING, BUT NOT LIMITED TO, LOSS OF PROFITS, DATA, REVENUE, PRODUCTION, OR USE, BUSINESS INTERRUPTION, OR PROCUREMENT OF SUBSTITUTE GOODS OR SERVICES ARISING OUT OF OR IN CONNECTION WITH THIS LIMITED WARRANTY, OR THE USE OR PERFORMANCE OF ANY PRODUCT, WHETHER BASED ON CONTRACT OR TORT, INCLUDING NEGLIGENCE, OR ANY OTHER LEGAL THEORY, EVEN IF AVERMEDIA HAS ADVISED OF THE POSSIBILITY OF SUCH DAMAGES. AVERMEDIA'S TOTAL, AGGREGATE LIABILITY FOR DAMAGES OF ANY NATURE, REGARDLESS OF FORM OF ACTION, SHALL IN NO EVENT EXCEED THE AMOUNT PAID BY YOU TO AVERMEDIA FOR THE SPECIFIC PRODUCT UPON WHICH LIABILITY IS BASED.

Governing Law and Your Rights

This warranty gives You specific legal rights; You may also have other rights granted under state law. These rights vary from state to state.



For warranty period, please refer to the warranty card.
